

型名 Type Number	F4100D
定格 Rating	60A

一般公差 / General Tolerance ±0.5

尺度 / Scale 3/2 単位 / Unit mm

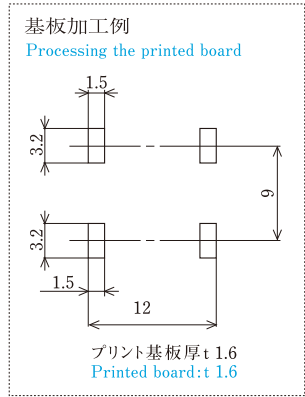
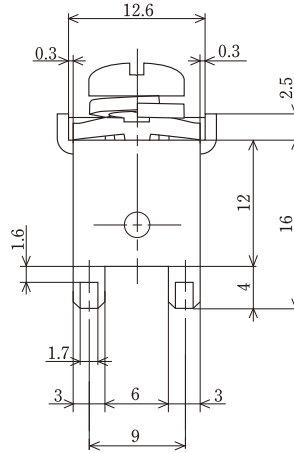
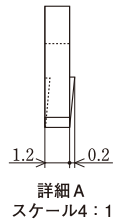
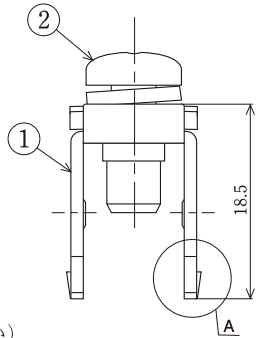

- 注文方法：型番
(下表の型番を御参照下さい)
- Ordering Form : Type No.
(See the type number in the following table)

仕様 / Specifications.

部番 / Part No.	名称 / Part Name	材質 / Material	寸法 / Size	処理 / Treatment
1	基板端子 Printed board terminal	黄銅 Brass	板厚 t=1.2	スズメッキ Tin-Plated
2	結線ビス Screw	鉄 Steel	SWCH・SPCC	ニッケルメッキ Nickel-Plated

型番 / Type No.	納入される物 / Product Delivered
F4100D	基板端子 (M5用) のみ (ビスなし) / Printed board terminal (for M5) only (w/o screws)
F4100D S	基板端子 + M5×12L フリータンシビス組付 / Printed board terminal + M5×12L Type ① screw attached

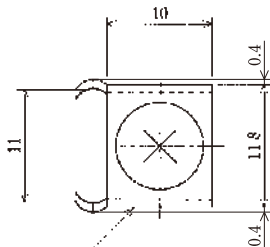
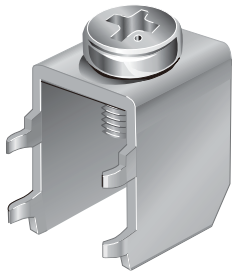

型名 Type Number	F4102C
定格 Rating	20A

一般公差 / General Tolerance ±0.5

尺度 / Scale 3/2 単位 / Unit mm

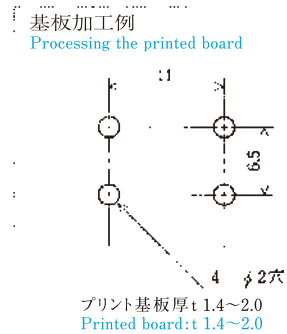
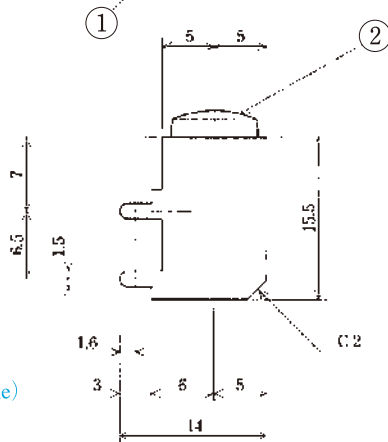

- 注文方法：型番
(下表の型番を御参照下さい)
- Ordering Form : Type No.
(See the type number in the following table)

仕様 / Specifications.

部番 / Part No.	名称 / Part Name	材質 / Material	寸法 / Size	処理 / Treatment
1	基板端子 Printed board terminal	黄銅 Brass	板厚 t=0.8	スズメッキ Tin-Plated
2	結線ビス Screw	黄銅 Brass		ニッケルメッキ Nickel-Plated

型番 / Type No.	納入される物 / Product Delivered
F4102C	基板端子 (M4用) のみ (ビスなし) / Printed board terminal (for M4) only (w/o screws)
F4102C S	基板端子 + M4×6L フリータンシビス組付 / Printed board terminal + M4×6L binding head screw attached